

# H.264 Standalone DVR 4CH/8CH



2010-06-12

# INDEX

<b>Chapter one Products Introduce.....</b>	<b>5</b>
1.1 Technical Parameter .....	5
1.2 Performance .....	6
<b>Chapter Two Hardware.....</b>	<b>8</b>
2.1 EZ2104/2108 4CH/8CH DVR .....	8
. Chapter Three Operation.....	12
3.2 Powering On .....	18
3.2.1 Boot-strap .....	18
3.2.2 Shutdown.....	18
3.3 Enter System Menu.....	19
3.4 Power-down and Revert.....	20
3.5 Preview .....	20
3.6 Recording operation.....	21
3.6.1 Manual recording.....	21
3.6.2 Playback video.....	22
3.6.3 Recording setting .....	23
3.6.4 Video Detection .....	26
3.6.5 Alarm setting and alarm linkage recording .....	30
3.7 Backup recording file.....	31
3.7.1 Detection device .....	31
3.7.2 Backup operation .....	32
3.8 How to control PTZ .....	33
3.8.1 Method of connection .....	33
3.8.2 The method of PTZ control operation .....	33
3.8.3 PTZ control.....	34
<b>Chapter Four Menu Operation Guide .....</b>	<b>36</b>
4.1 Menu Navigation .....	36
4.2 Menu Operation .....	39

4.2.1 Play Back.....	40
4.2.2 System Information .....	40
4.2.3 System Setting.....	44
4.2.4 Record Control.....	52
4.2.5 Hard Disk Drive Management .....	52
4.2.6 Alarm Control .....	53
4.2.7 Advanced Options .....	53
4.2.8 File Backup.....	59
<b>Chapter Five IE.....</b>	<b>60</b>
5.1 logging on interface .....	60
5.1.1 To input the IP address .....	60
5.2 System Settings.....	63
5.3 State control .....	65
<b>Chapter Six FAQ (Frequently Asked Questions) .....</b>	<b>67</b>

- **Power**

This DVR select the adaptor is DC12V; please make sure the power supply voltage before use the machine.

If long time do not use the machine, please turn off the power of DVR machine, and let the electric plug away from power socket;

- **safety**

This DVR only for indoor use, as for prevent short circuit or electric danger, please do not let the DVR in the raining or humid area.

In case any solid or liquid inside the case of DVR, please turn off the power immediately, and ask the qualified technician check it before reboot the DVR;

The DVR is the precision machine, there is nothing for repair by customers themselves in it, when it break down, please ask the qualified technician to check and repair, or contact with the agents of it.

- **Installation**

Please keep the DVR in level for installation;

Pay attention to equipment ground;

For the first time to install the DVR, please make sure if the hard disk drive install or not;

Prevent to open the case and change the hard disk drive in electrified;

Propose to select the performance of hard disk drive will be 7200 rotating speed person second;

Please select the appropriate installation site, so let the air can be free flow inside the DVR, prevent the machine overheating;

Please do not install the DVR nearby the radiator, air chute etc. heat source, or where the direct sunlight, too much dust, or mechanical vibration or attack;

# Chapter one Products Introduce

## 1.1 Technical Parameter

Compression standard	H.264 baseline profile@L3.1
Video input	Composite 1.0Vp-p/75Ω,BNC×4/ BNC×8
Video output	Composite 1.0Vp-p/75Ω,BNC×1; Super Video×1; VGA×1
resolution	Preview 720×576 (PAL), 720×480 (NTSC) 352×288 (PAL), 320×240 (NTSC) Recording 720×576 (PAL), 720×480 (NTSC) 352×288 (PAL), 320×240 (NTSC)
Bit rate	Preview/ recording 8ch 200fps(PAL), 240fps(NTSC)
audio input	-8dB~22k,RCAx4(4ch), RCAx8(8ch)
Audio output	-8dB~92dB,RCAx1
Audio decode	ADPCM
alarm input	Input low level alarm, user setting normal open or normal close, 8ch input
Alarm output	4ch output
Recording mode	Manual recording, timing recording , motion detection recording and external alarm recording
Simplex/duplex/ triplex	triplex(recording, playback , LAN transmission)
LAN	RJ45(10M/100M self-adapting)
PTZ control	Yes
communication	RS485×1, USB2.0×1
USB	USB mouse control
Hard disk drive	4x SATA (500GB or above)
Remote control unit	Yes
dimension	Main board size : 220mm x 112mm

Power supply	AC110-230V
--------------	------------

## 1.2 Performance

Real-time monitoring	Turn-by-turn analog video output and VGA interface, according to TV monitor or VGA monitor to live view in 1/4/8/9 or more video channel to monitoring the recording streaming and the record file capacity in every hours every channel, to presentation the status of video channel, recording, dynamic detection, video loss, monitoring lock-up. You can view the system log in local DVR.	Storage function	Internal 1 SATA interface, MAX 2TB hard disk drive, the file of hard disk drive include cover mode circulation recording and none cyclical recording, the storage data to use the proprietary format, can not falsify the data, make sure the data safety.
Compression format	Video compression format:: H.264 Support 8ch video and audio signal, video and audio maintaining stability in synchronous.	Backup function	Through USB interface to backup. ( for example USB drive and mobile hard disk drive etc.) The video file can be downloaded by Client software through LAN to laptop hard disk drive.
Recording and playback function	<ul style="list-style-type: none"> <li>* Multiplex, to achieve real time recording to be independent at the same time to single channel playback, research and backwards, network monitoring, network search download etc.</li> <li>* Multiple recording mode: Manual, normal, alarm, linkage, dynamic detection recording etc. turn-by-turn pre-recording function.</li> <li>* Can playback the record file in DVR through network, to achieve quick-search the recording file and recording type, multiple playback type: SLOW, Fast</li> </ul>	Network Operation function	<ul style="list-style-type: none"> <li>* through network to real time remote monitoring;</li> <li>* PTZ control</li> <li>* recording research and real time playback;</li> <li>* system setting parameter modify and the system software upgrade;</li> <li>* remote monitoring alarm process and view the system log message;</li> <li>* to use embedded TCP/IP protocol and Embedded Operation System, can access the DVR through client software program bundle in the package;</li> <li>* Management Model: use enhancement user management, password mode to make sure the valid user to login the system, flexible convenient and fast</li> </ul>

	Forward, Backwards, step Forward. Display the exact time of event occurred while recording file playback.		to set the different permission user requirement.
Alarm linkage function	8ch alarm input ( alarm event mode can be set normal open or normal close selection), and turn-by-turn video loss alarm, dynamic detection alarm, the alarm device may be smoke detection censer, temperature detector, IR detector. Possess 4ch relay switch alarm output, flexible convenient and fast to achieve alarm linkage and lighting control at site. They're possess protective circuit in Alarm input and alarm output port, make sure the device not to damaged.	Communication port	* Possess specific interface, achieve alarm input and PTZ control; * possess a standard Ethernet interface, achieve the network remote monitoring.
PTZ control	* Support PTZ decoder through RS485 communicate * scalable multiple decoder protocol, easy to achieve to control the pan driver and speed dome camera function.	Intelligent operation	* mouse operation function; * In menu for same setting and to process shortcut copy operation

## Chapter Two Hardware

### 2.1 EZ2104/2108 4CH/8CH DVR

#### 2.1.1 Front panel



Please refer to P3.1.1. For details of front panel function

## 2.1.2 Rear panel

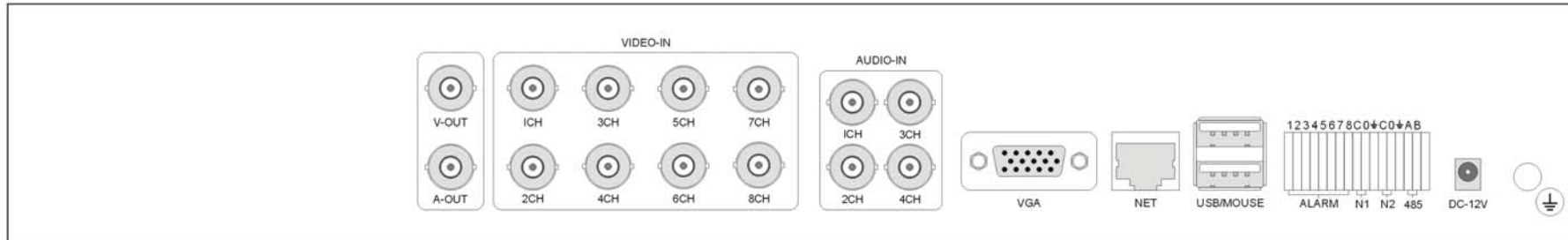

Item	Interface	Description
1	VIDEO IN	8ch video input
2	AUDIO IN	4ch audio input
3	V-OUT	1ch video output
4	A-OUT	1ch audio output
5	VGA	VGA monitor
6	NET	RJ45
7	USB1-BACKUP	First USB for backup or upgrade system of DVR
8	USB2-MOUSE	Second USB for mouse
9	ON/OFF	Power supply switcher
10	DC-12V	Power adaptor port
11		<p>ALARM IN: IN1-IN8 alarm input port</p> <p>RS-485: A, B</p> <p>ALARM OUT: 4ch alarm output port, every channel connect GND、OUT、COM; every two channel OUT, COM port is for GND;</p>

### 2.1.3 Alarm input port

8channel alarm input, the mode of alarm input is no restriction (possible is normal open also normal close);  
 the GND alarm detector connect to COM under parallel connection (the power of alarm detector supply by external power supply);  
 the ground terminal of alarm detector join-up in parallel with DVR;  
 the NC of alarm detector connect with the input end (alarm) of DVR;  
 when you want to reset the remote alarm of triggered , the +12V power supply of alarm detector supply by DVR, for example, smoke detector.  
 When you select the external power supply, please share the GND with DVR;  
 Alarm input circuit:

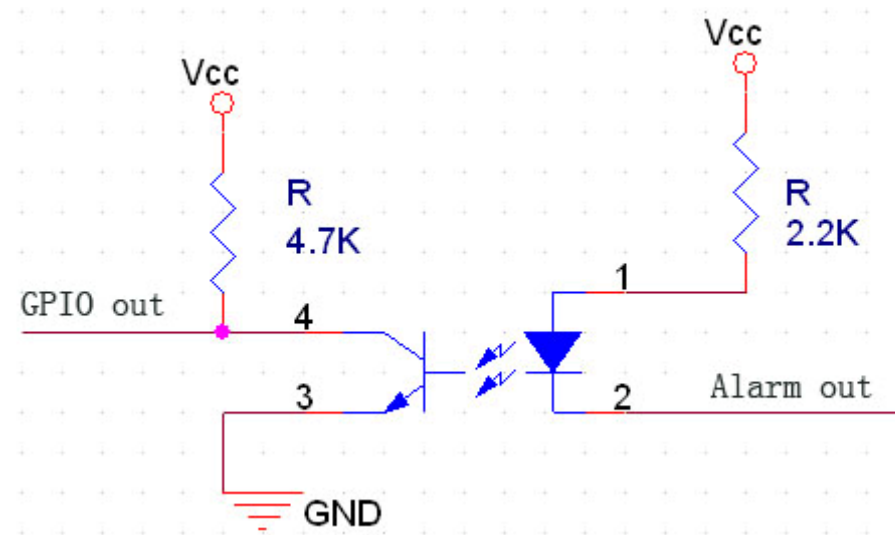

Alarm inlet connection:

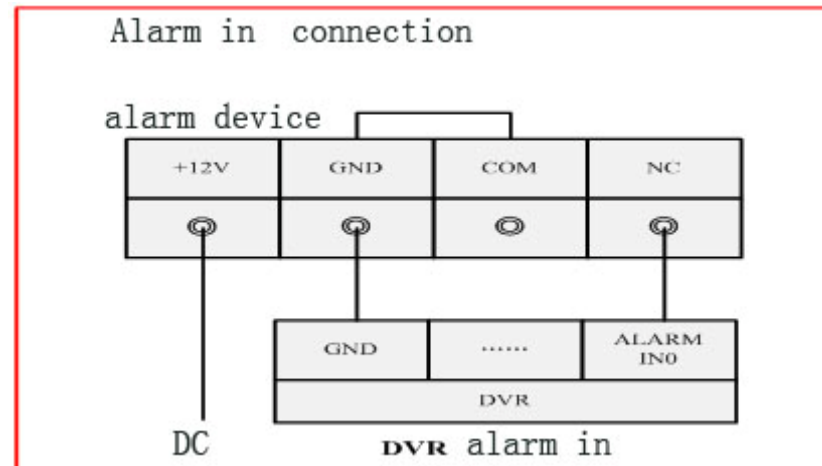

### 2.1.4 Alarm output port

4 way switching value alarm output, selectable in normally open contact, also selectable in normally closed contact, the external alarm device should be need Vcc;



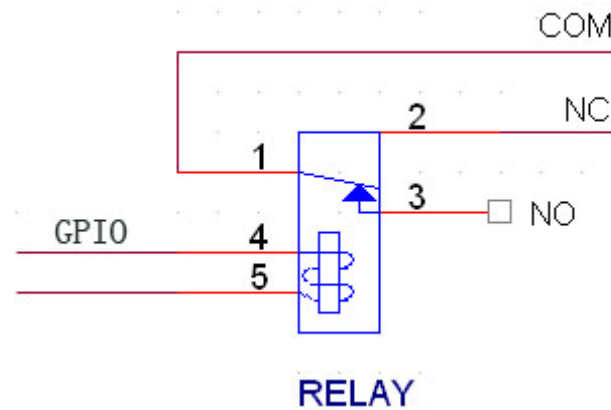



alarm outgoing circuit:



# Chapter Three Operation

## 3.1.1 Front panel keypad



Item	Keypad Name	Description
1	0~9	Digit input key
2	FN	Function key, correspond to the right key of mouse
3		Switching of 1/4/8/9 Preview mode
4	MENU	Menu keypad, press this key can input Main menu
5	ESC	Exit operation or enter upper menu
3	PTZ	PTZ function, press this key enter the PTZ control interface
8	REC	Press this key enter the recording control interface
9	SEARCH	Press this key enter playback video interface
10		To stop the playback/pause while playback video
11		To stop the playback while playback video
12		To reduce the playback speed while playback video
13		To adjust the playback speed in 2/4/8 times speed while playback video
14		Four-way to move the focal point in main menu, up and down to move in the normal window, to control pan driver to move in the PTZ control windows
15	ENTER	Enter
16	POWER	To start the DVR power while in standby Keep to press the key in 3 seconds, the system will automatically to turn off the power of DVR
17	SHIFT	When press key SHIFT,the key for digital put

### 3.1.2 How to use mouse of DVR (for right hand mouse)

1	Left key single click	To any function menu icon click the mouse left key into the menu
		To run the control point out operation
		Change again select frame or motion detection piece mode
		Click the assemble frame popping to pull down the list
		In the input frame, can select digit, character, lowercase, block letter, left click mouse on the keyboard of character input, that's. ← say move back, _ say blank

0	1	2	3	4	5	6	7	8	9
a	b	c	d	e	f	g	h	i	j
k	l	m	n	o	p	q	r	s	t
u	v	w	x	y	z	␣	Aa	⊙	←

2	Right click mouse	<p>Right click mouse, popping the shortcut menu, as follows;</p>  <p>while life view monitoring, popping short cut menu: multi picture mode, recording mode, PTZ control, clear alarm,enable listen into, video adjustment, recording control, main menu etc short cut manner. Thereinto, the PTZ control and video adjustment manner are set the video channel where cursor locates at that time, before setting, if the mode if multi picture, then the system can automatically switch to the correspondence single channel picture.</p> <p>In the title bar, if you click right key of mouse wherever outside of the edit box and the button, it will close current window.</p>
3	Double click left button	To run the ActiveX Control ActiveX special operation, For example, double click the certain item of record listed file, then the system will playback the segment record video.
4	Dragging the mouse	<p>Depress the left key and dragging the mouse, banding select Motion detection area, depress right key of mouse and Dragging, cancel the banding select area.</p> <p>Dragging playback ProgressBar back and forth to dolly moves, to achieve the playback position adjustment. Dragging the audio and video regulation parameter bar dolly moves, to achieve the parameter adjustment.</p>

### 3.1.3 Remote control

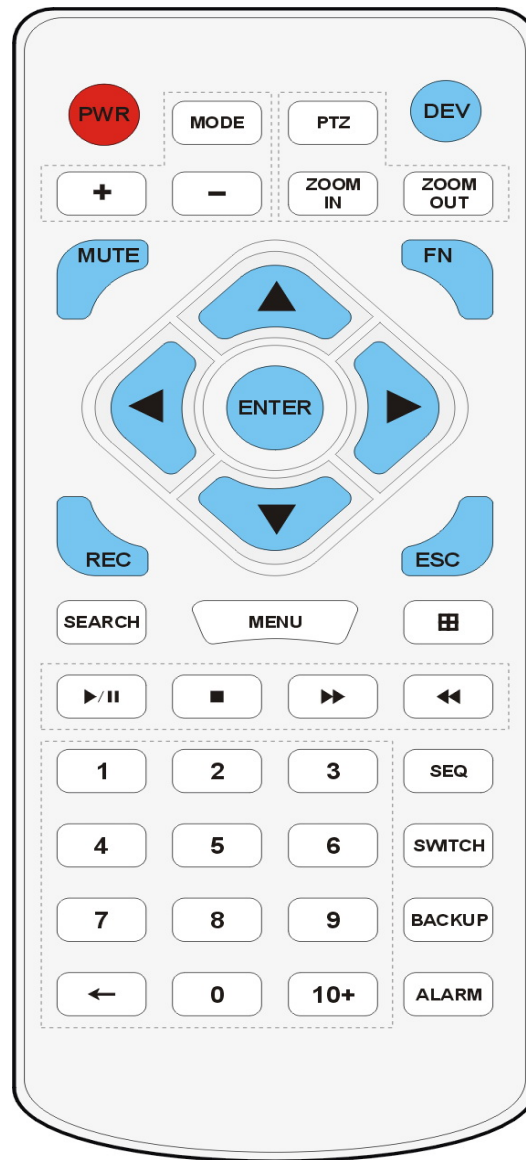

S/N	KEY	Operating instruction	S/N	KEY	Operating instruction
1	【PWR】	Power ON/OFF	9	【ENTER】	This button is used as “enter” key in most circumstances
2	【DEV】	Select DVR1, 2, 3, ...	10	【SWITCH】	Switch capital letter/small letter/symbol input on soft keyboard
3	【MENU】	Access main menu	11	【MODE】	Switching of Lens IRIS/FOCUS/ZOOM modes
4	【ESC】	Close soft keyboard Close current window Exit from current control Return to last menu Exit from PTZ control under preview state	12	【PTZ】	Access/exit from PTZ control under preview state
			13	【+/-】	Volume or number increase/reduction Select item of the list
			14	【ZOOM IN/OUT】	Lens control
5	【◀◀】	Slow playback, 1/2 ×, 1/4 ×, 1/8 × and single frame play	15	【MUTE】	Mute enable/disable
	【▶▶】	Fast playback, 2×, 4× and 8× playback	16	【0~9 10+】	Digital input Corresponding; Channel is magnified in full screen under preview state
	【■】	Playback stop			
	【▶/  】	Play / Pause	17	【FN】	Short cut
6	【REC】	To mode of recording	18	【田】	Switching of 1/4/8/9 Preview mode
7	【SEARCH】	Search for playback	19	【ALARM】	Alarm reset
8	【SEQ】	Skipping, and polling control when starting polling setting	20	【BACKUP】	Backup of recording

## 3.2 Powering On

### 3.2.1 Boot-strap

If **【POWER】** pilot lamp off, please follow the operation step by step:

First step: if the power does not plug into, please plug into the power, then the DVR-4108 begin to start, by now, if the DVR-4108 still inactive, to enter the next step;

Second step: turn on the power supply of the DVR-4108 at the back panel, DVR begins to start.

If **【POWER】** pilot lamp to offer RED, press the **【POWER】** key, DVR-4108 begins to start.

The video output mode of DVR-4108's the default setting is multi picture channel mode after starting the DVR-4108, if the time of start the DVR-4108 is in the Timing Recording Setting, the DVR-4108 will automatically to start the Timing Recording function, the corresponding channel's recording pilot lamp will be light, the DVR-4108 is normal operation.

If you do not install the hard disk drive in the DVR-4108 before turn on the power, after Login the system, the system will call attention to as follows;

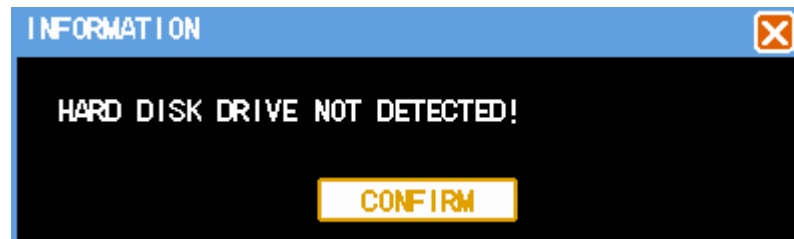

### 3.2.2 Shutdown

◆ **There are two safety mode for Shutdown**

A. Pressing the POWER key in 3 second, according to Shutdown warning to stop the all running of DVR-4108, then you can turn off the power key behind the DVR case.

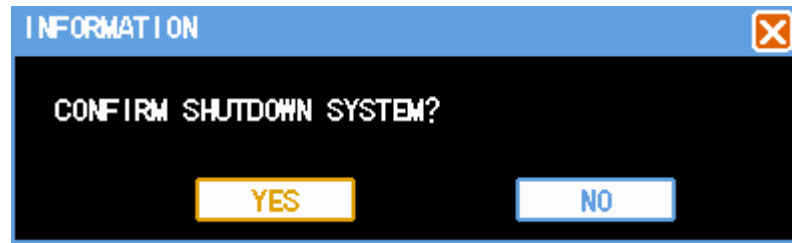

B. Enter **【Main Menu】** → **【Log Out】** select **【Shutdown system】** .

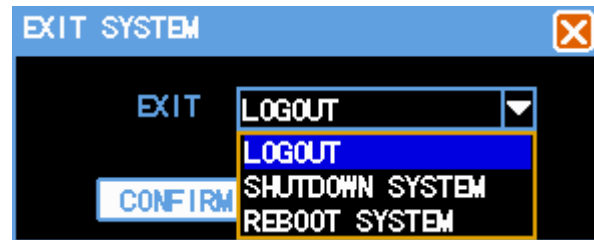

#### ◆ Abnormal shutdown

##### Through the rear panel to shutdown

During the DVR-4108 running, directly to turn off the power through the rear panel power switch, please avoid as much as possible to do it. (specially while the DVR recording).

##### Directly to pull up the power cable of DVR-4108

While the DVR-4108 running, directly to pull up the power cable of DVR-4108, please avoid as much as possible to do it. (specially while the DVR recording).

**Caution:** In some area, the power supply is irregularity, it will cause the DVR-4108 working not normal-operation, the DVR-4108 will be damaged in serious. In this surroundings, suggest select the stabilized voltage supply.

## 3.3 Enter System Menu

#### How to enter the Menu Mode

- Press **【MENU】** key, enter main menu
- Click **【Mouse right key】** enter shortcut menu
- Click **【T-RSH】** shortcut, enter playback menu
- click **【REC】** shortcut, enter manual recording operation menu
- Click **【PTZ】** shortcut, enter PTZ control operation menu

Introductions: you should input the user name and password when you login DVR system, the default user name is “admin”, and the password is “666666”.

There are three default user, that’s “admin, user, default”, and the user and default’s password is “123456”. The user name “admin” is the top authority user in default, and the “default” is the low authority user in default, only for monitoring, playback, backup etc. authority.



Password security: you can try 5 times in 30 minutes, otherwise, the user name will be locked;

Remark: for safety, suggest to change the password after use the DVR-4108, put the additional user name and change the default user name, for the use setting please refer to Menu operation---User management.

Concerning the input method: except the front panel and remote control unit can be input, you also can input the character in the InputBox, single left click the mouse, the system will dropping the software keyboard.

## 3.4 Power-down and Revert





When the DVR run under Recording, Timing recording, Alarm Recording, if the power of DVR to be turn off or be forced to turn off, and turn on the power again, DVR will automatically save the recording before turn off, and automatically to revert the operating condition before turn off to work on.

## 3.5 Preview

After log in system of DVR, system will automatically directly enter the preview mode

In the preview picture, you can see the overprint date, time, channel name, if the date and time is not correct show on the picture, re setting the date. There is a alarm input mode icon. (the meaning of every kind of icon as following table)

## Channel picture attention

1		When that channel recording, this mark will be showed on it	3		When there is a video loss in that channel, this mark will be showed on it
2		When there is a motion detection alarm in that channel, this mark will be show on it	4		The mark of alarm input mode
5		When the video be Dodging, this mark will be showed on that channel			

## 3.6 Recording operation

Customer can according to select the different kind of recording mode in this system. For the different kind of recording mode you set, the channel will be showed the mark on everyone channel.

### 3.6.1 Manual recording

**Note: Manual recording operational requirement the user should have “recording” permission. Please make sure the hard disk drive has been installed and it has been formatted.**

#### 1) Input manual recording operation menu

Single click right key of mouse or In main menu=> recording control can into manual recording operation menu. Under preview mode, press REC key or on the Remote controller unit key into recording control operation menu, as follows:

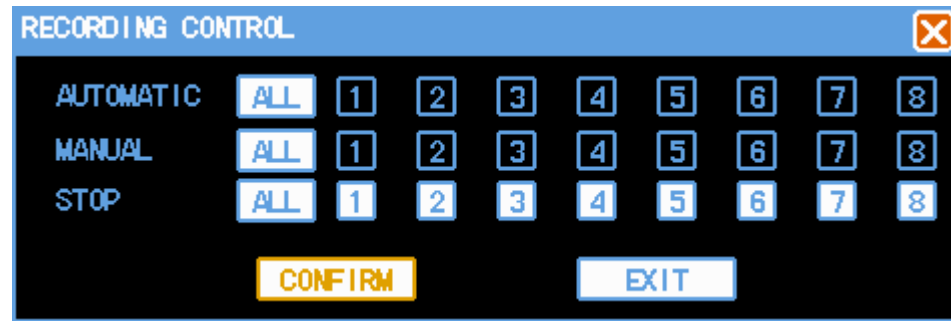

## 2) The explanation of manual recording operation menu

- 【manual recording】 Priority level highest, no matter currently what status of every channel, after carry out the manual press, corresponding channel will be record common in progress;
- 【Auto recording】 Setting channel recording by setting condition to record under Timing, Motion detection and Alarm in Recording Setting;
- 【Stop Recording】 All video channel stop recording;
- 【All 】 Possible to select all video channel recording or stop recording.

## 3.6.2 Playback video

There are two mode in video playback: One channel playback and four channel playback at same time.

One channel playback: Single click right mouse key in anyone video channel under Preview menu, select “Record Playback” in the popping menu, search the record file and playback in the popping recording file menu, then the record that selected will be play backed in that video channel.



Four channel playback: 【Main menu】 → 【Record Search】 , click the icon of mark file in the red frame as follows;

Select the corresponding video channel to search, double click the record file to playback; then move the mouse to the Second video channel to search the record again, double click the record file and playback the record file in it; to do the same step mention above, you can playback four channel record file at the same time.

Toolbar of playback



Button	Description	Button	Description
	Playback/pause		Open the record file
	stop		Single video channel playback mode
	From quick playback, slow to normal play back mode		Four video channel playback mode
	Slow, fast		
	Sound on/off		Hide the toolbar
	Voice adjustment		Close the window menu

### Note:

- 1) During playback the Playback Tool will show the file playback speed, channel, timing, playback speed etc. information in the Playback control panel;
- 2) Can't same time to select the Fast forward operation function in over 2 channel, only progress in anyone channel;
- 3) Can drag the Playback Speed toolbar by mouse;

## 3.6.3 Recording setting

Two mode in recording: Manual Recording and Auto Recording

### 3.6.3.1 Manual Recording

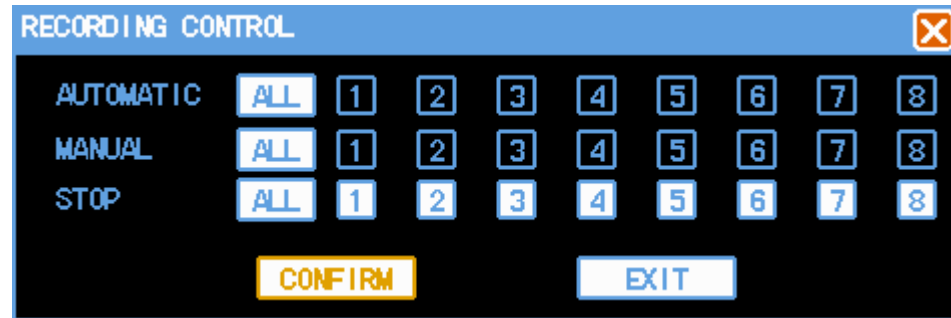

Click **【Main Menu】** → **【Recording Control】** , as above diagram,select anyone channel to recording, the White color means the recording function enable,Black color means disable;

Also can select “All” mark,if select it, then the recording function enable in all channel, click confirm.

### 3.6.3.2 Auto Recording

The Auto Recording function includes;

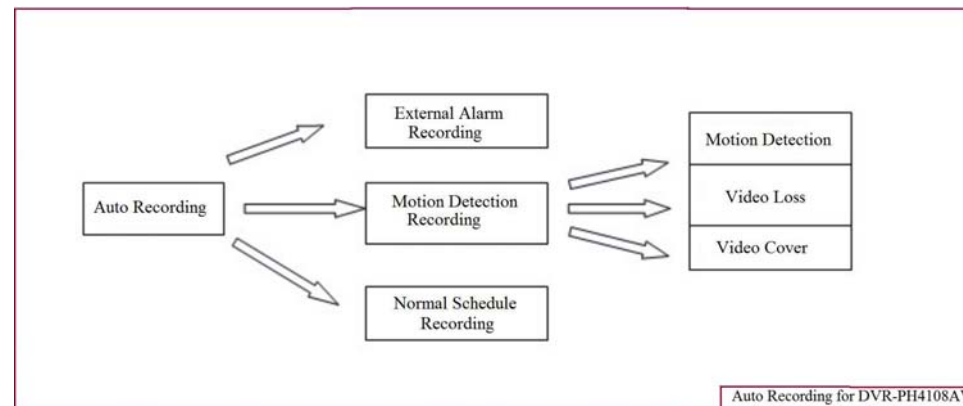

External Alarm Recording: Please find the details of it in 3.6.5 in this menu (Alarm setting and Alarm linkage Recording)

Normal Schedule Recoding: The default setting is 24hours non-stop recording after the First time to boot the DVR system. Login the menu, can set the Timing of DVR to record continually, that's recording in the timing that you select in sometime area, find the details setting in **【Main Menu】** → **【System Setting】** → **【Recording Setting】**

Motion Detection Recording: Please find the details of it in 3.6.4 in this menu (Motion Detection)

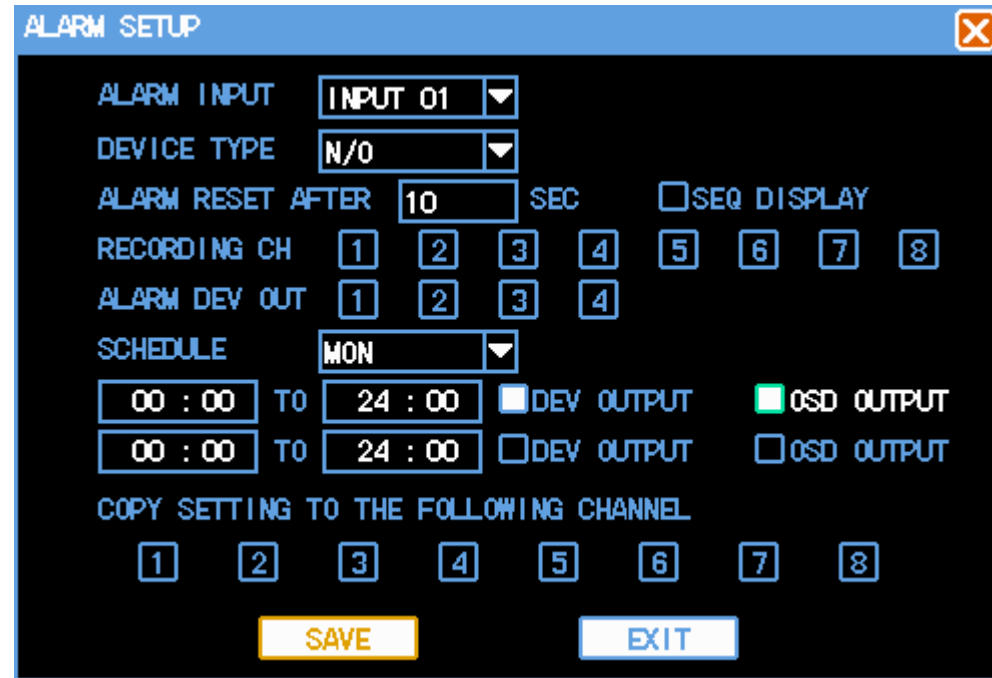

Including the time slice of setting Normal Recording, Motion Detection Recording, Alarm Recording;

【Channel】/【Recording Schedule】 Drop-down menu, select the corresponding channel Number/Week to set, select “ALL” can set the all channel function enable in onetime;

【Alarm Recording】 Can record 3-5seconds video before the alarm event to occur (the timing depends on the capacity of video streaming) ;

【Time Slice】 The means the recording mode of that channel currently in some time, “■” anti-display setting normal, alarm recording mode, can select single or multi in it, four time slice for setting selectable. Under some recording mode and the time in different time slice, you can duplicate to set, the time setting range is 00:00—24:00, after set the channel parameter, please press the save key to save the setting in the system.

### Shortcut setting

- 1) Duplicate the same setting from one channel to another channel, for example, select channel one, after recording mode setting, click the copy icon into the others.
- 2) User should save the setting one by one after channel setting.

### 3.6.4 Video Detection

**Note:**

- 1) Select **【Main Menu】** → **【System Setting】** → **【Video Detection】** to enter the setting menu;
- 2) During motion mode switch, there is not None Area and Sensitivity setting in video loss and video cover detection;
- 3) When there is a motion detection event in one channel, the symbol of motion detection will show in the channel;
- 4) No need to use FN function key when you drag the motion detection area by mouse, click the right key of mouse to save the setting before exit, the user press the SAVE to confirm before exit the Motion Detection menu.

## 1) VIDEO Detection

To excessive the video picture, when the system detect the motion event that the sensitivity fit for the preinstall, then motion detection alarm on.

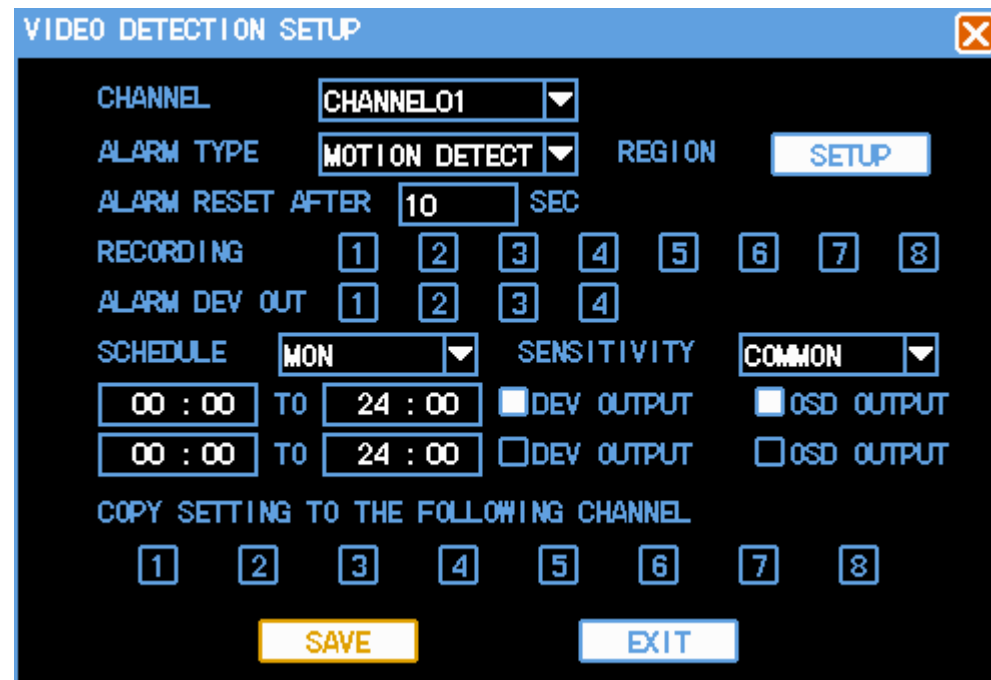

### Method of Operation:

- 【Channel】 Select what you want to set the motion detection function channel area;
- 【Alarm Mode】 Select the motion detection mode: Motion Detection;
- 【Recording Channel】 Select what you want to need the channel to recording (can repeat to select), when there is a alarm, the system can automatically to start the recording in that channel, At the same time, should set the motion detection recording mode in 【Recording Setting】 , set the Auto Recording mode in 【Recording Control】 ;
- 【Clear Time Delay】 That means, when the motion event finish, the recording will be stopped in extending time, the time in Second, the range from 5-300;
- 【Channel Cruise】 Anti-display ■ Setting when there is an alarm event, it will automatically to switch the single channel video that set the recording channel before. The switching time setting in the 【Local Display】 setting;
- 【Region】 Move the mouse to setting, press ENTER key to enter; the set region divide into 192 (16x12) region;

The border blocks representatives where the cursor locates, the green region is dynamic detection security region, achromatic color is open

security region. Press <Fn> key to set on security or not, set the on security press direction key to move the green border grid to set the dynamic detection region, after setting, press <ENTER> confirm to exit dynamic detection region setting, if press <ESC> exit dynamic detection region then it will cancel the all security setting. When you exit the dynamic detection menu, must to press save key to save the setting, otherwise, the dynamic detection security function is disabling.

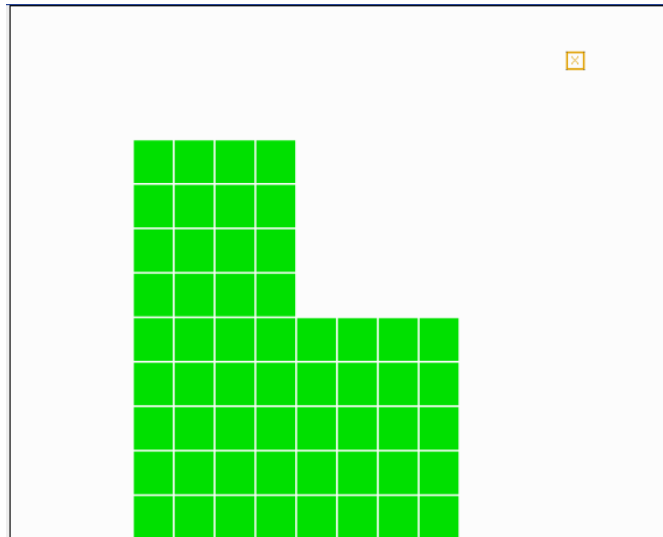

【Sensitivity】 You can set them to: Highest, high, normal, low, lowest;

【Alarm output】 When there is dynamic detection event, to start the linkage alarm output port to the external alarm device;

【Screen presentation】 Invert signify show happen dynamic detection, it will show the prompting message;

【Time Slice】 Can set the alarm output situation in two time slice, please do not set the repeat in the time slice setting, alarm output and prompting message option invert the corresponding channel option selector button, that's there is an alarm to start alarm output or prompting message in the selected time slice.

## 2) Video Loss

When there is a video loss situation, select 【Alarm Output】 and 【Screen presentation】 that's the video loss message shows on the local screen.

### Method of Operation:

【Channel】 Select that channel what you want to set the dynamic detection region;

【Alarm Mode】 Select detection mode: Video Loss;

【Recording Channel】 That means it needs to record video (multi selectable) when there is a video loss, when there is an alarm, the system will automatic start to record in that channel. At the meantime, select the dynamic detection recording in the 【Recording Setting】 ,

select the automatic recording in **【Recording Control】** ;

**【Clear Time delay】** That means after the dynamic, the recording will be stopped in some time delay, the time unit is in second, the range is 10-300;

**【Channel Switcher】** When there is an alarm in Invert setting, the single video channel will switch in that selected to start record channel, the time of channel switcher setting in **【Local Display】** setting;

**【Alarm Output】** When there is a video loss, start the linkage alarm output port to the external alarm device;

**【Time Slice】** Can set alarm output situation in two time slice, the time slice setting allow in repeat, the system according to the selected operational context to press or operate in the current time slice. That is if there is a prompting message in the current time slice One, no in time slice Two, then there is a prompting message in this time slice. Alarm output and prompting message selection invert, that's there is an alarm output or prompting message in the selected time slice.

### 3) Video Cover

When some body malice to cover the lens of camera, or due to the lighting caused etc. lead to the video output display in monochrome attic, that is unable to monitor scene video. Through the Video Cover alarm setting, it can effective to prevent phenomenon to happen, select **【Alarm Output】** and **【Prompting Message】** .

### Method of Operation:

**【Channel】** Select that channel you want to set the Dynamic Detection region;

**【Alarm Mode】** Select detection mode: Cover Detection;

**【Recording Channel】** That means it needs to record video (multi selectable) when there is a video loss, when there is an alarm, the system will automatic start to record in that channel. At the meantime, select the dynamic detection recording in the **【Recording Setting】** , select the automatic recording in **【Recording Control】** ;

**【Clear Delay】** That means after the dynamic, the recording will be stopped in some time delay, the time unit is in second, the range is 10-300;

**【Channel Switcher】** When there is an alarm in Invert setting, the single video channel will switch in that selected to start record channel, the time of channel switcher setting in **【Local Display】** setting;

**【Alarm Output】** When there is a video loss, start the linkage alarm output port to the external alarm device;

**【Time Slice】** Can set alarm output situation in two time slice, the time slice setting allow in repeat, the system according to the selected operational context to press or operate in the current time slice. That is if there is a prompting message in the current time slice One, no in time slice Two, then there is a prompting message in this time slice. Alarm output and prompting message selection invert, that's there is an alarm output or prompting message in the selected time slice.

Explanation:

1. During copy the setting what you did before, only copy the same setting what you want to set. That's say, the setting of video loss can not be ed to paste to video cover after copied (For example: the cover detection of Channel One only be copied to the others channel's cover detection, can not be copied into the other mode) , by parity of reasoning.

2. In the default operation process, according to the different setting of channel and detection mode, only to detect the mode of current channel in default operation. For example, default operation in cover detection menu, only set cover detection in default, the operation can not to set the other detection mode.

3. Caution: you can select the short cut copy function to set the same channel, but in video detection setting, that can not be copy to use the dynamic detection copy function region parameter, because there is not same in everyone channel video.

### 3.6.5 Alarm setting and alarm linkage recording

Details setting in **【Main Menu】** → **【System Setting】** → **【Alarm setting】**

User should separate to save after to everyone channel setting.

The screenshot shows the 'ALARM SETUP' menu with the following settings:

- ALARM INPUT: INPUT 01
- DEVICE TYPE: N/0
- ALARM RESET AFTER: 10 SEC
- SEQ DISPLAY:
- RECORDING CH: 1, 2, 3, 4, 5, 6, 7, 8
- ALARM DEV OUT: 1, 2, 3, 4
- SCHEDULE: MON
- Schedule 1: 00 : 00 TO 24 : 00,  DEV OUTPUT,  OSD OUTPUT
- Schedule 2: 00 : 00 TO 24 : 00,  DEV OUTPUT,  OSD OUTPUT
- COPY SETTING TO THE FOLLOWING CHANNEL: 1, 2, 3, 4, 5, 6, 7, 8
- Buttons: SAVE, EXIT

**【Alarm Input】** Select corresponding alarm channel Number;

- 【Device Mode】 Select normal open/normal close (voltage output);
- 【Channel Switcher】 Invert  setting when there is an alarm event, due to select start to record the channel progress to single channel switching display, select the switching setting time mode in the menu 【Output Mode】 ;
- 【Recording channel】 Select the require recording channel( repeat selectable), when there is an alarm event, the system will automatic to start that channel to record. At the same time, select the dynamic detection recording in 【Recording Setting】 , select the automatic recording in 【Recording Control】 ;
- 【Alarm Output】 Alarm linkage output port ( repeat selectable) ,when there is an alarm event, can be linked the corresponding alarm output device.
- 【Clear Time Delay】 Select corresponding time delay (5-300, the unit in second) ,after clear the external alarm, system automatic to delay the corresponding time, then close the alarm and linkage output;
- 【Prompting message】 Show the prompting alarm message in the local DVR;
- 【Time Slice】 Can set alarm output situation in two time slice, the time slice setting allow in repeat, the system according to the selected operational context to press or operate in the current time slice. That is if there is a prompting message in the current time slice One, no in time slice Two, then there is a prompting message in this time slice. Alarm output and prompting message selection invert, that's there is an alarm output or prompting message in the selected time slice.

## 3.7 Backup recording file

The backup of Standalone DVR can be by SATA DVD-R/RW, USB DVD-R/RW, USB storage device, download through LAN etc. First to introduce the USB storage backup operation, please find the details of it in the LAN client operation download backup through LAN.

### 3.7.1 Detection device

The backup device are USB DVD-RW, pen drive, mobile hard disk drive etc. devices, it will show the detection device in the file backup device. And show the total storage file capacity.

- 【Detection】 Click Detection button, if use the USB backup device in the USB port, then show the display device mode, partition in the above list box;
- 【Remove】 Click the Remove button, the installed mobile USB device will be uninstalled, the information of device will be clear in the list box;

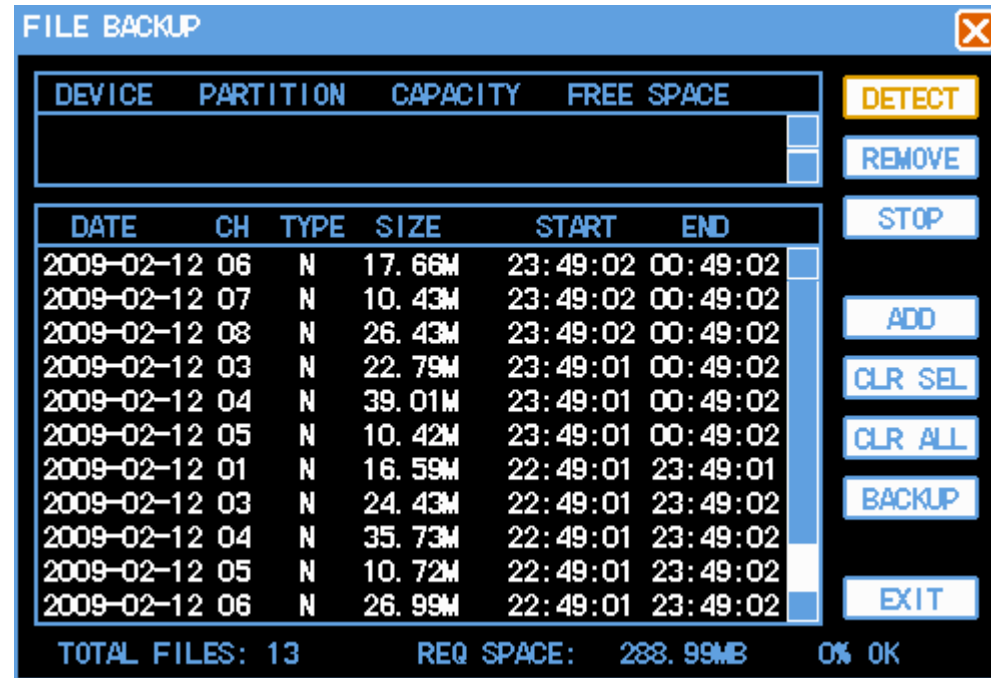

### 3.7.2 Backup operation

【Add】 Click the backup dialog box "Accession" button, popping "Recording Searching". Searching the DVR record file according the time, channel, searching mode etc. information, searching information show in the dialog box. One or more file to add selection in one time, after process, the file will be showed in the "file backup" diagram dialog box that the file need to backup.

【Delete】 You can delete the one or more file in the "file backup" dialog box file list frame, the operation will be delete the content list only, and do not delete file;

【Clear】 Clear the content list in the dialog box;

【Backup】 To backup the all file in the dialog box into the appointed backup device, before the backup operation, please confirm the selected backup device, and it has enough space to backup.

**During the backup operation, you can process to the other operation, after the backup furnish, it will automatic to show the successful information. The backup task cannot be canceled.**

You can check the backup video file in your personal computer, the format of video file is: channel name + year/month/day/hour/minute/second.lvf

## 3.8 How to control PTZ

### 3.8.1 Method of connection

- 1) connect RS-485 port of speed dome camera with the DVR PTZ port ;
- 2) connect the video cable of speed dome with the DVR video input jet ;
- 3) turn on the power of speed dome after connected mention above;

### 3.8.2 The method of PTZ control operation

- 1) the current video channel must switch to that channel camera will be controlled in the video channel;
- 2) finish setting the ID of speed dome;
- 3) confirm if it is correct or not from the cable A,B of speed dome to the cable A,B of DVR, (please see the details of in chapter II: 2.1.2)
- 4) process corresponding setting in DVR menu, details setting in **【Main Menu】** → **【System Setting】** → **【PTZ Setting】** .

PTZ SETUP

CHANNEL: CHANNEL01

DEV ADDRESS: 0

PROTOCOL: Pelco\_D

BAUD RATE: 9600bps

DATA BIT: 8

STOP BIT: 1

CHECK: NONE

FLOW CONTROL: NONE

COPY SETTING TO THE FOLLOWING CHANNEL

1 2 3 4 5 6 7 8

SAVE EXIT

【Channel】 Select the connect channel of camera;

【Protocol type】 Select the corresponding brand model protocol of speed dome camera;

【Address】 Setting the corresponding ID of speed dome camera;

**Caution; the ID and protocol setting of DVR should fit for the speed dome camera, other wise, you can not control the speed dome camera through RS-485 of DVR;**

【Baud rate】 Select the corresponding baud rate of speed dome camera, can control to the corresponding channel PTZ and camera, the default setting is 9600;

【Data bit】 Default is 8;

【Stop bit】 Default is 1;

【examination】 Default is None;

【Flow-control】 Default is None;

PTZ setting should be saved in everyone channel after setting.

### 3.8.3 PTZ control

To control the 【direction】,【speed】,【aperture】,【focus】,【Iris】,【cruise control】,【cruising setting】,【scan boundary】,【back light Compensation】,【auto scan】 Of PTZ, coordinate with the direct key during setting;

There are two different kind of control interface in PTZ control, in preview mode, click right key of mouse in everyone channel, the shortcut menu will popping the “PTZ Control” selection as follows.





【Assist On/Off】 Can call the user-defined assist function, for example, lighting, windshield wiper etc;

【Preset setting】 Preset point setting;

【Call preset】 Call the preset point setting;

The function call display menu interface in 【Main menu】 → 【PTZ control】 as follows;

The setting of pan driver step length through the inferior level slid bard of direction key to adjust. Major for neck rein operation, the step length is more and more longer then the rotational speed follows;

Direct to single click the key of  ,  of zoom, focus, IRIS, adjustment for zoom, definition, illumination.



The rotation of pan driver can supports 4 direction, there is Up, Down, Left and Right.





The **【Boundary Scan】**setting move to control the JIONT of speed dome, left margin setting, horizontal shifting move to the another point, to set the right margin.



**【Auto Scan】** after the running Auto scan, can control the it running in Auto Scan in the left and right boundary of speed dome camera.

# Chapter Four Menu Operation Guide

## 4.1 Menu Navigation

Main Menu	First level menu	Option remarks
 Play Back		To achieve the function of record file searching and playback, the listing of searching according to the record mode, channel, timing, display the result situation in listing, process the playback after the record file select ed. R-Normal recording, A-Alarm recording, M-Motion detection recording
 System information	<b>Hard disk drive</b>	The interface position of SATA hard disk drive, the total capacity, surplus capacity, the start-stop recording time information of all hard disk drive and everyone. Mode: read-write drive, read-only drive etc.
	<b>Log</b>	Display the log of system important event, and record the log appointed.
	<b>version</b>	Display the property of system hardware, software version and the day of release
	<b>Online user</b>	Check the information of on line user
 System Setting	<b>System setup</b>	System time, preservation mode of record, the DVR model etc. basic parameter
	<b>Encoding setting</b>	Encode mode, bit rate, quality parameter etc. setting of audio and video,
	<b>Recording setting</b>	The timing setting includes the timing recording, dynamic detection, external alarm event; The duration of everyday timing operation in one week( recording, receive external alarm event, running dynamic detection), the every mode can be set in two different kind of duration in everyday
	<b>PTZ setting</b>	Parameter setting of PTZ

	<b>Network setting</b>	The parameter setting of network ID, video data transmission protocol etc. and the function of PPPoE, DDNS.
	<b>Alarm setting</b>	The parameter setting of for external alarm output and record response.
	<b>Video detection</b>	The dynamic detection parameter setting of sensitivity, region and pre-processing (alarm output and start recording) , video loss, blank screen detection etc.
	<b>Local display</b>	The parameter setting of output menu and monitoring switching Caution: after the menu modify output attribute, the presentation will be go to take effect after system reboot.
 <b>Recording Control</b>		On or Off the channel recording
 <b>Hard disk drive management</b>		The operation of Hard disk drive management, clear the data in hard disk drive; Attention: modify property of hard disk drive, it will take a effect after the system reboot.
 <b>Alarm control</b>		PTZ Advanced Features Alarm input, output function
 <b>Advanced</b>	<b>User account</b>	The user management function
	<b>Exception</b>	
	<b>System upgrade</b>	The item need to system maintenance setting, upgrade function

<b>Options</b>	<b>Output adjustment</b>	Adjust the output parameter of VGA
	<b>Revert default</b>	According to select revert all or part of it into default delivery setting Attention: user account setting is not the recovery function
 <b>File backup</b>		Detection backup device Listed the detected device, display the name, mode and capacity etc. Backup the record file into the backup device.
 <b>Turn off system</b>		Log off, turn off, reboot system operation

## 4.2 Menu Operation

Main menu interface introductions



The main menu function includes recording search, system information, system setting, recording control, hard disk drive management, alarm control, Advanced Options, file backup, turn off system.

### Explanation:

The all-following sub-menu setting should to take effect after save, otherwise, the setting invalid.

The checkbox be filled means that someone function sleeted, not be filled that means no select some one function.

## 4.2.1 Play Back

To achieve the recording search and playback function, the listed searching according to the recording mode(all, normal, alarm, dynamic detection), channel, timing to search, please see the result listed table( please see chapter III 3.6.2)

## 4.2.2 System Information

Sub-system menu: hard disk drive information, log information, version information, on-line user.



### 4.2.2.1 Hard Disk Drive information

Display SATA hard disk drive interface status, mode, all hard disk drive and everyone hard disk drive interface position, total capacity, available capacity etc. information.



#### 4.2.2.2 Log Information

Show the system log, convenience of customers to see the login log.

The log message type can be divided into system operation, setting operation, data management, alarm event, recording operation, user management, clear log file, file operation, setting the time slice of log what you want to search, directly to press Search button, system will display the record log listed, press Page up or Page Down key to search the page turning operation.

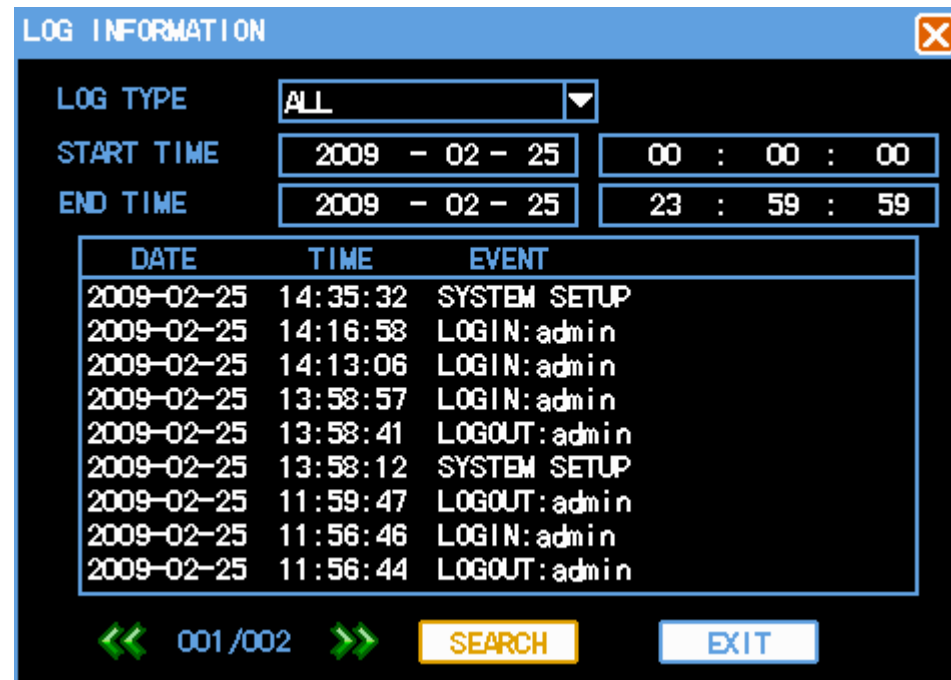

The user who has the limits to rights can clear the date log in the system.

### 4.2.2.3 Version Information

Display the system hardware characteristic, software version and release date code etc information.

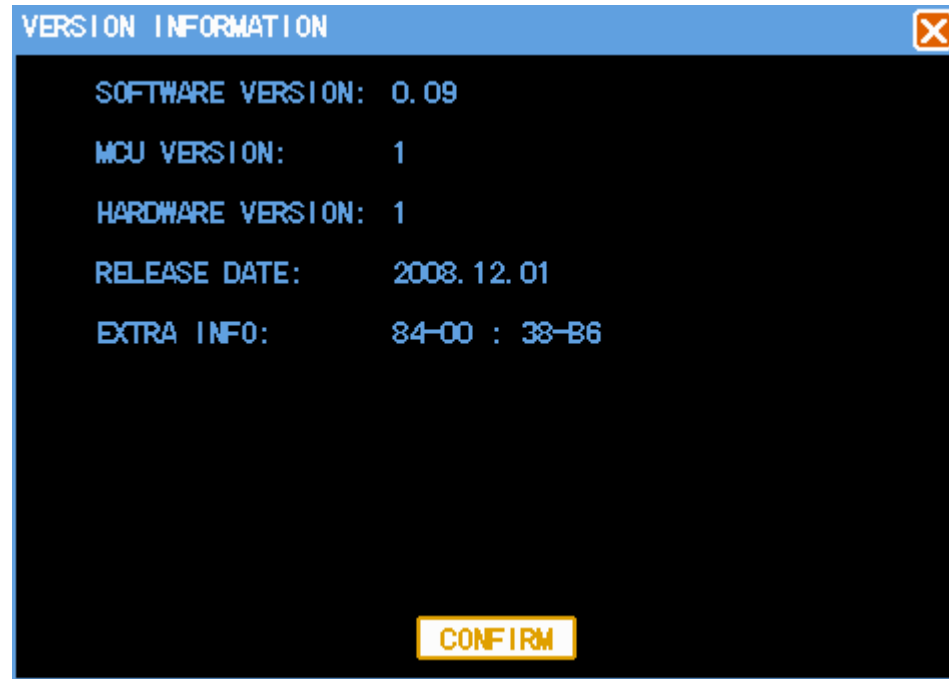

#### 4.2.2.4 Online user

To see the LAN user information who log in the local DVR.

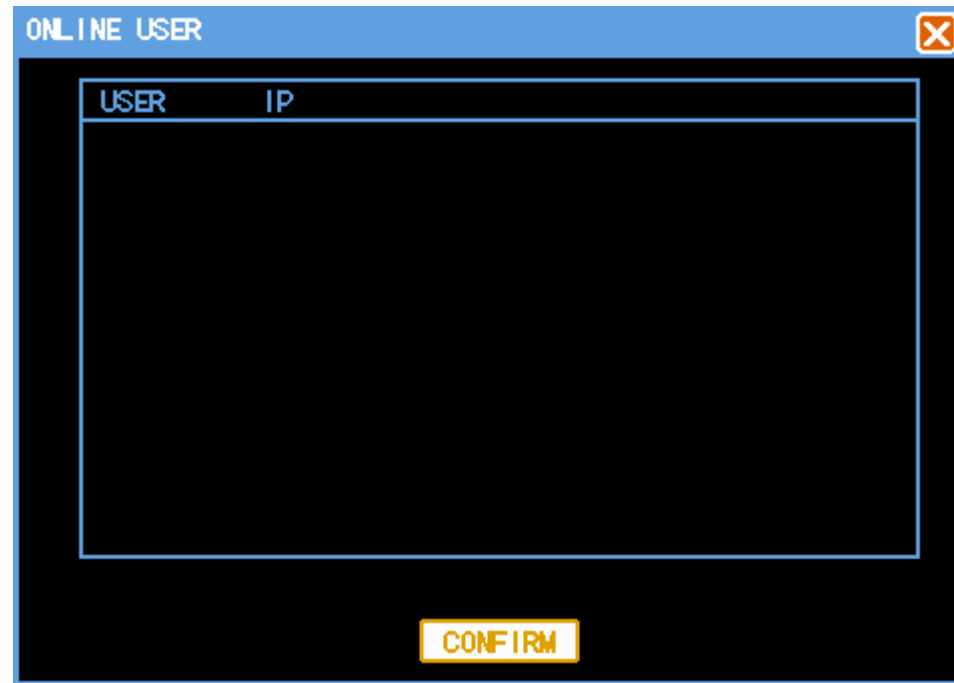

### 4.2.3 System Setting

Sub-Menu: 【System Setup】 , 【Encoding Setting】 , 【Recording Setting】 , 【PTZ Setting】 , 【Network Setting】 , 【Alarm Setting】 , 【Video Detection】 , 【Local Display】 etc. menu.

Please see the details of 【Recording Setting】 , 【PTZ Setting】 , 【Alarm Setting】 , 【Video Detection】 in Chapter III.

**Attention: System setting must login by who hold the limits to rights**



## 4.2.3.1 System Setup

The screenshot shows a 'SYSTEM SETUP' window with the following fields and options:

- SYSTEM TIME:** 2009 - 02 - 25 | 14 : 43 : 07
- DATE FORMAT:** YYYY MM DD
- SEPARATOR:** -
- TIME FORMAT:** 24 HOURS
- LANGUAGE:** English
- DVR ID:** 0
- VIDEO SYSTEM:** PAL

Buttons: SET TIME, SAVE, EXIT

**【System Time】** Be used for modify the current system date and time of DVR, click the right hand side button to save the modification;

**【Date Format】** Select the date display format, including year/month/date, month/date/year, date/month/year etc;

**【Date separator】** There are three different kind of selection in it, “—” “/” “.”, if you select “.”, then the system time will display as: 2008.07.20

**【Time Format】** Including 24 hours and 12 hours;

**【Recording Length】** Can setting the duration of everyone recording file, default is 60 minutes;

**【Identification Number】** Be used for the situation that use one remote controller unit to over one DVR, only press the ID of remote controller unit on it and the same corresponding DVR ID number, so, you can control the DVR;

**【Video System】** According to setup setting different system;

**【Menu Standing by】** Possible to set the menu standby-time 20-60second, 0 is not set the standby-time, if you Setup time, behind that time slice, system automatic log off the current login user, if the user wants to operate menu, must to login again.

## 4.2.3.2 Encoding Setting



【Channel】 Select channel Number;

【Encoding Type】 Select “audio & video” then the recording file will be audio and video composite streaming, select “video” the streaming will be video only;

【Encoding Size】 CIF/Half D1/D1;

【Streaming Control】 Including fixed bit rate, dynamic bit rate;

【Encoding Quality】 6level video quality, they’re best, well, good, middle, worst, bad;

【Code Rate】 Max 1 Mbps, Min64Kbps;

Caution: when the code rate control set into dynamic bit rate, the default setting will be the upper limit in the 【Code Rate】 ;

【IP Gap】 From 0 to 255 adjustment to continues, 0 means full I frame pattern encoding;

【Frame Rate】 1fps to 25fps in PAL, or 30fps UNCAL;

【Default】 Channel is the First channel, encoding type is video, resolution is CIF, streaming control is dynamic code rate, the code rate upper limit is 512Kbps, frame rate is 25fps;

【Region Override】 Invert, press the appear setting button and cover type selection, enter the corresponding channel video, user can select any size area to cover by mouse, anyone can not monitor or playback the area that has been set the cover area before;

【Time Overlap】and【Character Overlap】Overlap everyone channel encoding, there are time and channel title overlap, can set if you want to overlap where the time and channel overlap in the encoding data, single click the setting button, drag the time title or channel title to good place. If overlapped, the time and channel message will be display on video file when you playback the record file.

#### **4.2.3.3 Recording Setting**

Please find the details of it at Chapter III 3.6 (Recording Operation).

#### **4.2.3.4 PTZ Setting**

Please find the details of it at Chapter III 3.8 (PTZ Control Operation).

### 4.2.3.5 Network Setting

The image shows two overlapping configuration windows. The top window is titled "NETWORK SETUP" and contains the following fields and buttons:

- ETHERNET IP: 192 . 168 . 0 . 121
- NETMASK: 255 . 255 . 255 . 0
- GATEWAY: 192 . 168 . 0 . 1
- DNS: 0 . 0 . 0 . 0
- Buttons: MAC, EMAIL, SAVE, EXIT

The bottom window is titled "MAC ADDRESS" and contains the following fields and buttons:

- MAC Address: 00 - 84 - E6 - 52 - 65 - D5
- Button: CONFIRM

Below the MAC ADDRESS window, the "NETWORK SETUP" window is partially visible, showing:

- PPPoE IP: 0 . 0 . 0 . 0
- ACCOUNT: [Empty field]
- PASSWORD: [Empty field]
- Button: DIAL UP

NETWORK SETUP

EMAIL SETUP

EMAIL ENABLE       SSL      EMAIL TEST

SMTP SERVER

SNEDER ADDRESS

SENDER USER

SENDER PASSWORD

CONFIRM PASSWORD

RECEIVER ADDRESS

CONFIRM      CANCEL

【IP Address】 Press Up/Down/Left/Right key or input the corresponding numeric key to modify the IP address parameter value ( the IP address setting can be set in this setting item), then set the subnet mask and Default Gateway of the corresponding IP address;

【Server Port】 The general default is 7777, according to set the port under the user actual-need (remark: the server port 7777 preserve for UDP port, please do not configure for the others);

【HTTP Port】 General default is 80;

【Start Multicast】 Start Multicast network transmission modes, turn on the multicast function nee to set the corresponding multicast address and port;

【Start DDNS】 Via DDNS server, it compatible with DYNDNS.ORG, NO-IP.ORG, support [www.3322.org](http://www.3322.org) DDNS server;

【Start PPPoE】 Input ISP ( Internet Service Provider) user name and password provided by PPPoE, reboot the system after save the setting. After boot the DVR, system will automatic to setup the PPPoE network connection, after successful setting, the IP of 【IP address】 will be modify automatically achieved the Internet dynamic IP address;

Operation: After PPPoE dialup successfully, please check the IP on 【IP Address】 , achieved the currently IP of DVR, then access the IP of DVR through client.

#### 4.2.3.6 Alarm Setting

Set alarm output port, Invert  that means selected, press confirm button to save and exit, press cancel button to cancel and exit, manual to turn On/Off the corresponding alarm output port.

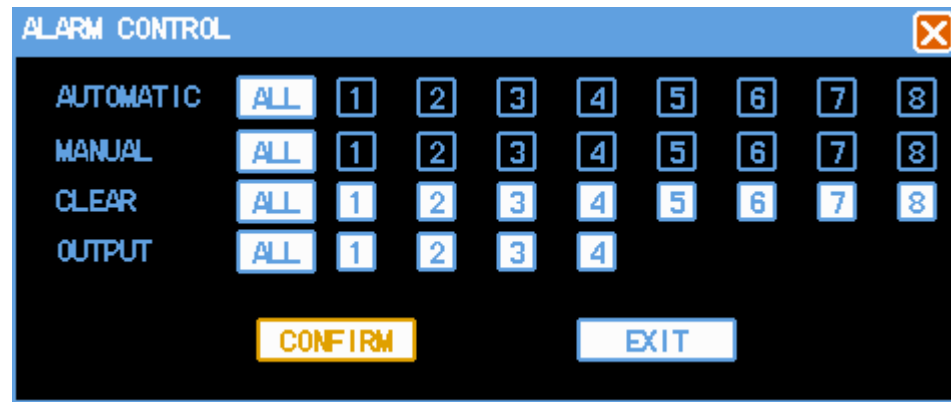

#### 4.2.3.7 Video Deteciton

Please find the details of it at Chapter III 3.6.4 (Video Detection).

#### 4.2.3.8 Local Display



- 【Channel Name】 Press the channel name modify button, enter the channel name menu, can modify the name of channel, during modify the channel name in local, the WEB or client do not update the new channel name immediately follow the local DVR modify, need to open the channel name to upgrade the channel name in WEB or client;
- 【Window Color】 According to the user favor to choose the background color and transparency;
- 【Transparency】 There are three type for select: 25%, 50%, 75%;
- 【Time Overlap】、【Channel Name Overlap】 Status invert  marking, display the system date time and channel number in the monitoring video;
- 【Start Switching】 Invert signify Start Switching function;
- 【Switching Gap】 Setting switching time, switching blanking time is 5-120 second, the switching video including single video and quad video. The 8 selected video frame signify the channel of switching in the single frame, the two selected switching video frame has four frame video in one bar (1, 2,3,4 channel is First page, the others is Second page), the single and quad video frame can be switched at the same time, if you selected 1,2,5,7 in single video frame, at the same time, slected quad video frame in the Second page, when there is a switching, it will First to display in spacing 1,3,5,7, then display the quad video frame in the Second page.

## 4.2.4 Record Control

Please find the details of it at Chapter III 3.6.3 (Recording Setting).

## 4.2.5 Hard Disk Drive Management

Host hard disk drive setting management, enter **【Main Menu】** → **【Advanced Options】** → **【Hard disk drive management】** .

The following pictures show the properties current hard disk drive: type, status, total capacity, capacity, available capacity. The red cross mark means there is not hard disk drive be connected to DVR, the yellow cross mark means there is a connected hard disk drive but it should be formatted, green hook means the hard disk drive can be used. Operate to format the all data on the hard disk drive, Press Execution button to operation, after finish, press confirm button and the system will presentation should reboot the system for confirm.



After formatted hard disk drive, the file format is ext3.

## 4.2.6 Alarm Control

Please find the details of it at Chapter III 3.6.5 (Alarm Setting and Alarm Linkage Recording).

## 4.2.7 Advanced Options

The Advanced Options including menu: hard disk drive management, user account, system maintenance, output regulation, Revert Default.



### 4.2.7.1 User Account

Management user account properties

The user name max character size is 8 character, the beginning and the end of the string is bland invalid, it can not be blank in the middle. The legal character: letter, numeral, not allowed to use the other character symbol.

The user quantity max is 20pcs, the user can be added in user-defined, but the name of user can not be same repeat, the everyone user name can be modified permission by admin, the other user name can permission modify the password themselves;

Modify password: permission to modify the password of user name, select user name, input the new password in the new password and confirm the new password again. Press save button for confirm the password modification. The password can be set from 1-8pcs, the password can not be in blank at the beginning and the end, the middle allow in blank. The legal character: letter, numeral, not allowed to use the other character symbol.

**Caution: The current password means the user logins**

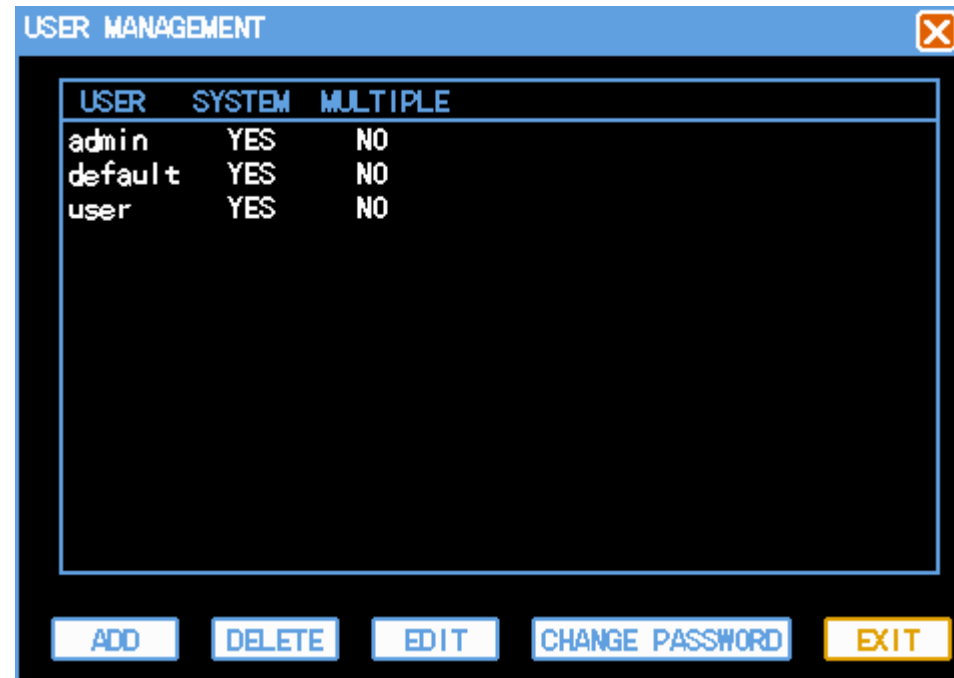

The screenshot shows a window titled "USER MANAGEMENT" with a close button in the top right corner. Inside the window is a table with three columns: "USER", "SYSTEM", and "MULTIPLE". The table contains three rows of data:

USER	SYSTEM	MULTIPLE
admin	YES	NO
default	YES	NO
user	YES	NO

Below the table are five buttons: "ADD", "DELETE", "EDIT", "CHANGE PASSWORD", and "EXIT". The "EXIT" button is highlighted in yellow.

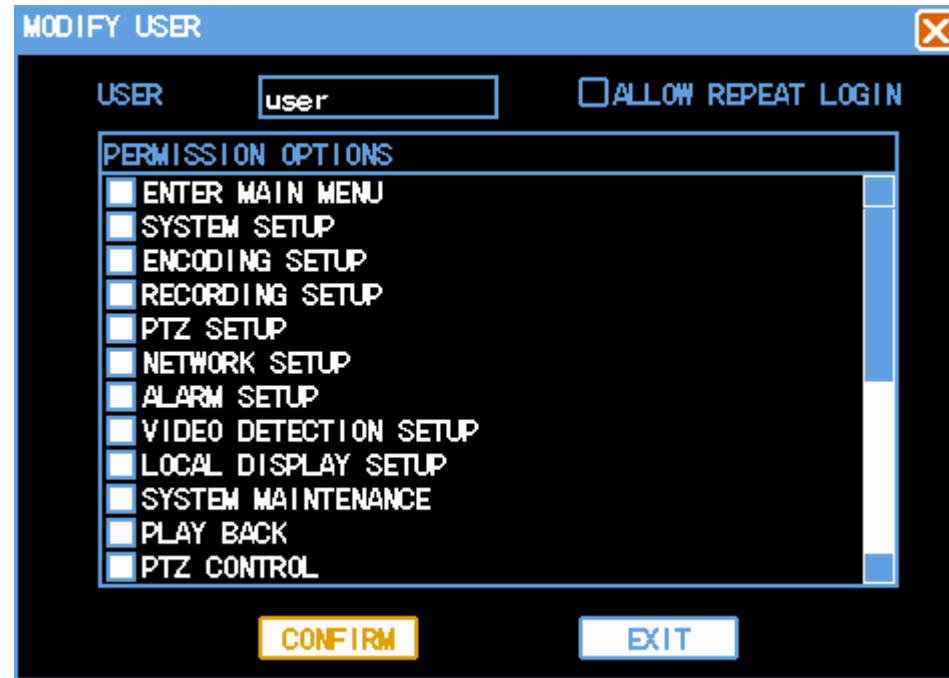

Add user: add user name in group and set the user permission control. Enter add user menu interface, input user name and password, select it which group does belongs to, and select is it multiplex user or not. Multiplex means that user can be used at same time, the user name can be used by some client at same time, “■” means selected.

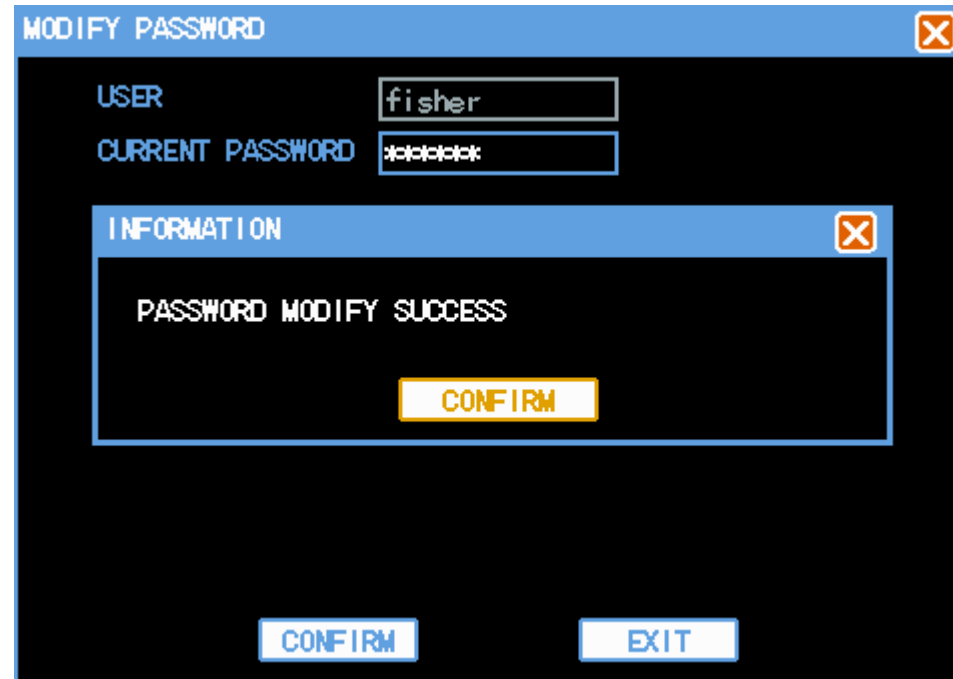

There are 3 user name admin,usrer,default in initialization, admin is the highest permission in delivery default setting, and the password is 666666,and the default user name is low permission user under delivery default setting, only can monitoring, playback, backup permission etc.

Default: this user is for system internal use, can not be deleted. When there locates “no user login” situation at local DVR, system will automatic to log in under this default user name. user can according to modify the permission of this user account, accomplish the operation of some no need to login. The other user who have account permission can modify the permission of Default, that is, user can use this function when there is not user login DVR, For example, if you want to view some video channel when there is not user login, you can select the permission in that corresponding video channel in Default account, scalable setting the others permission setting.

#### 4.2.7.2 Exception

### 4.2.7.3 System Upgrade

Set the item can Autonomous Maintenance.

User can set the automatic reboot system themselves, the automatic reboot system need to set the date and time, (please make sure to set the enable function in DVR where longtime no body to look for it. Finally to click the confirm button, otherwise, it will be canceled. User can copy the upgrade firmware software into USB drive, click the “start upgrade” button, after finished upgrade successful, the system will reboot automatically.

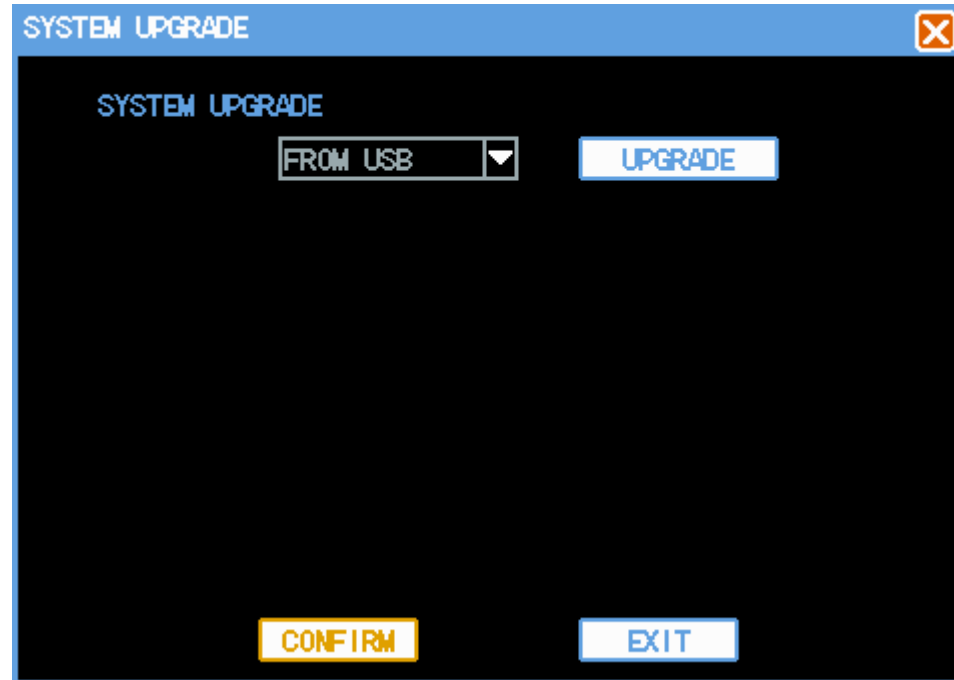

#### 4.2.7.4 Output Adjustment

Adjust the VGA output area, brightness, chromaticity and resolution.

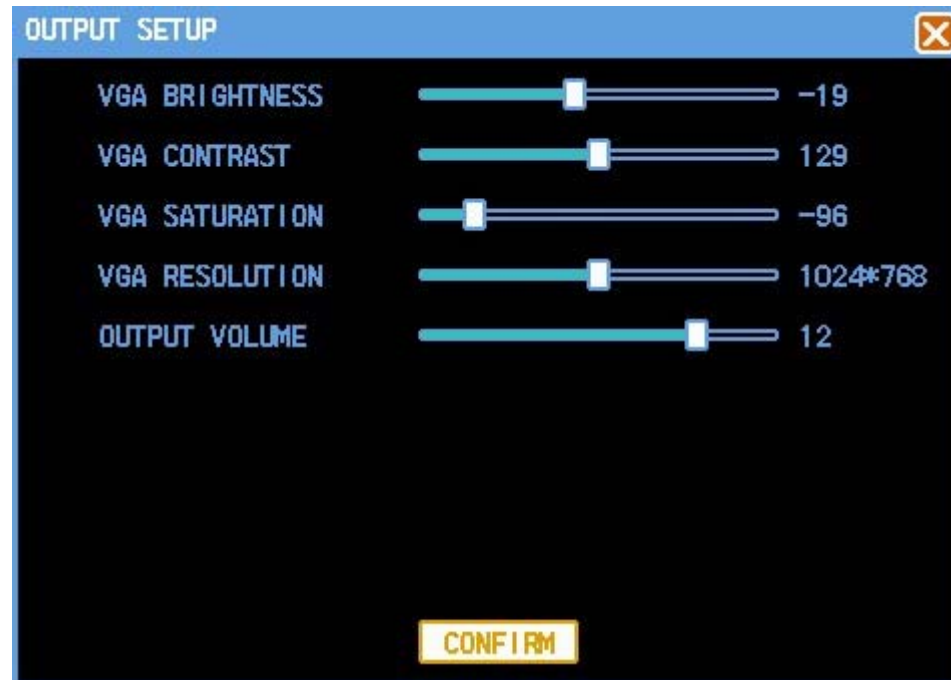

#### 4.2.7.5 Revert Default

System revert to the default setting status of Delivery (according to revert the details selected in the menu).

**Attention: Menu color, language, date time format, video system, IP address, user account etc. can not be reverted.**



#### 4.2.8 File Backup

Please see the details of it at Chapter III 3.7 (The Backup Operation of Recording File ).

# Chapter Five IE

## 5.1 logging on interface

### 5.1.1 To input the IP address

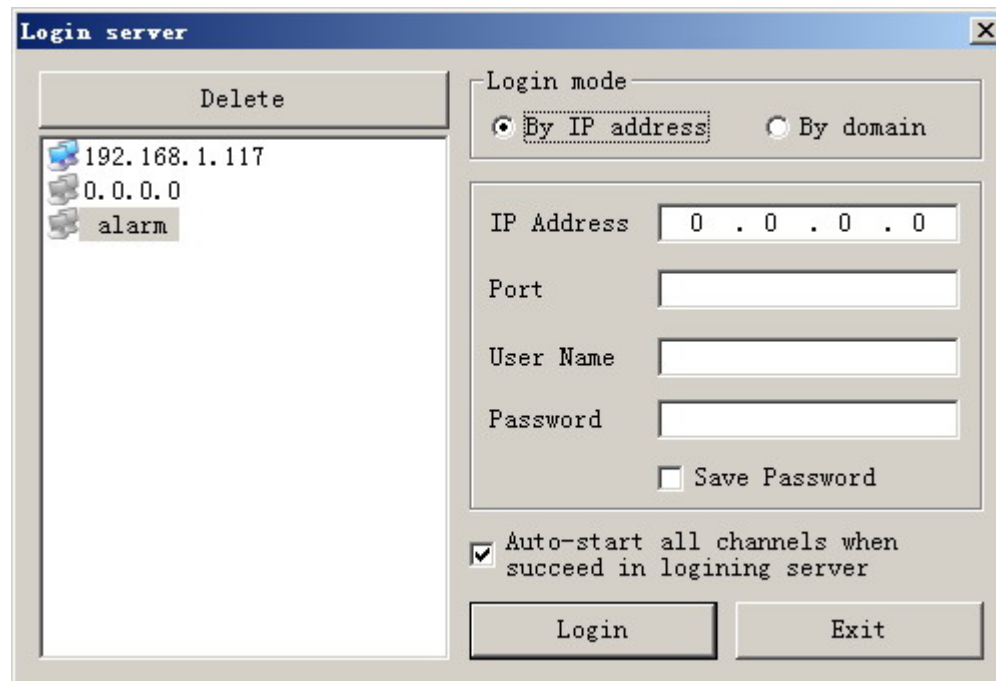

Login server

After succeed in logining or logouting server, exit dialog

Delete

Server	Alias
59.33.44.195	59.33.44.195
192.168.0.171	192.168.0.171
192.168.0.153	192.168.0.153

Login mode  
 By IP address  By domain

IP Address

Port

User Name

Password   
 Save Password

Auto-start all channels when succeed in logining server

From window  to start preview

Server alias

Prepermission IP address is 192.168.0.117



## 5.2 System Settings

Setup

Point , As the picture , You can set up language directory, After all to save you set.

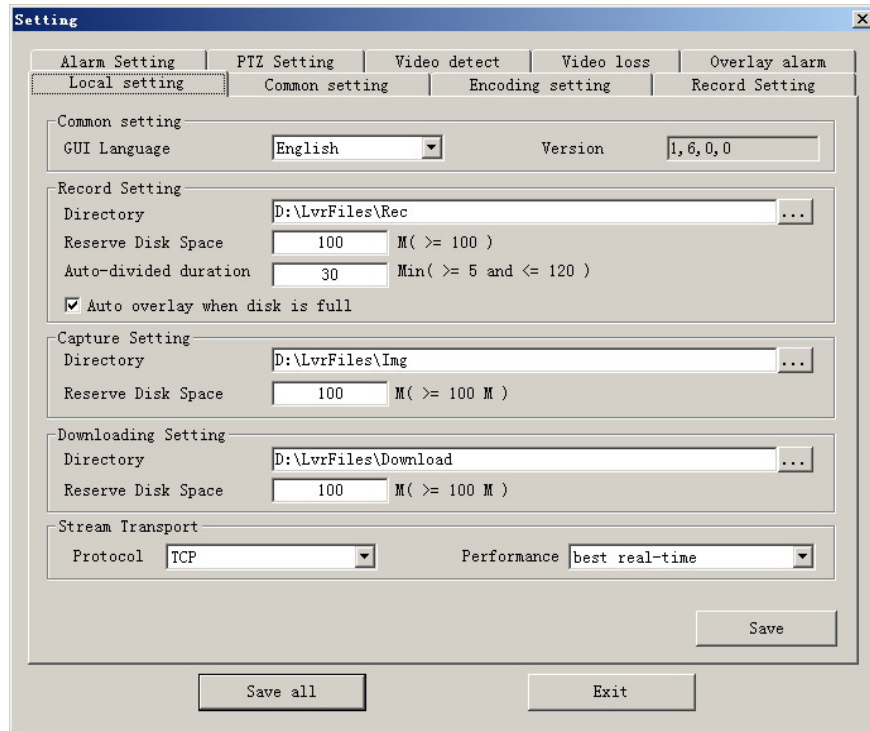



## 5.3 State control

In state control you can set reboot server, close server , remote to go up

Remote upgrade: let PC file load in the system

Log: to inquire sometime the server's action

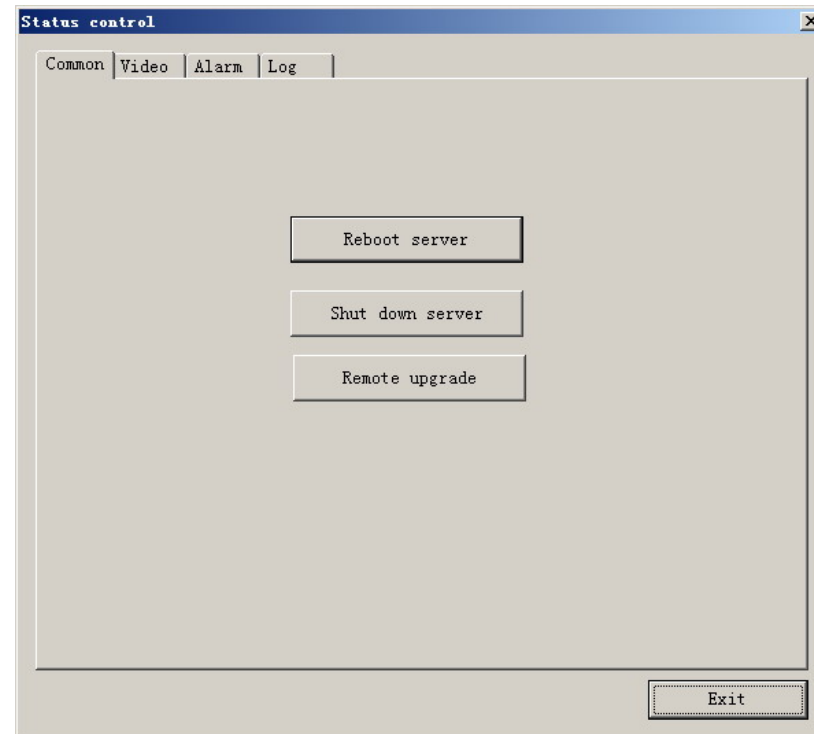
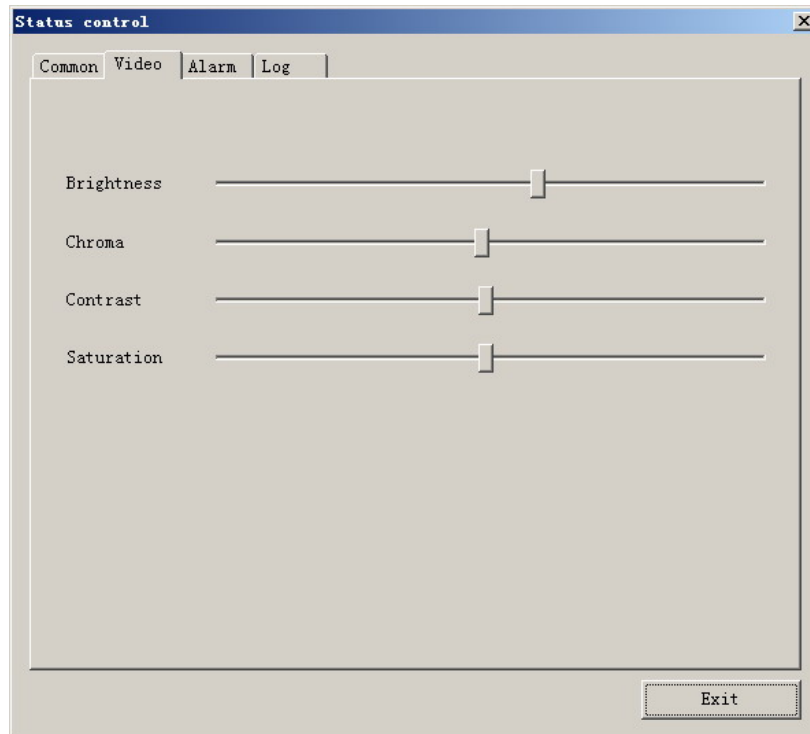

Status control

Common Video Alarm Log

Start time 2009- 2-12 0:00:00

End time 2009- 2-12 23:59:59

Log type All log Search

Log type	Oprating	Time	Event
----------	----------	------	-------

Exit

Status control

Common Video Alarm Log

Alarm out 1













Alarm out 2

Alarm out 3

Alarm out 4

Exit

## Chapter Six FAQ (Frequently Asked Questions)

- ?** 01: Why the DVR did not run after connect the power supply?
-  ①Please check the power switch turn on or off at the rear panel of DVR.
  -  ②Please check if the turn on DVR operation correct or not?
  -  ③If you select the adaptor +12V, 5A or above? (8ch 5A, 16ch 220V 200W)
- ?** 02: Still stop over on the boot-strap frame?
-  Physical damaged in hard disk drive
  -  Boot manager abnormal.
- ?** 03: Why does appear the boot running too slow?
-  ①There are too much capacity data in hard disk drive, the system will automatic search the data when the system boot up, caused the boot running slow.
  -  ②The hard disk drive error will cause the system research the data repeatedly, caused the boot running slow.
- ?** 04: Why does the system reboot repeatedly?
-  ①Check the hard disk drive, if there is not the FAT32 formatted in it or the problem in it and caused the DVR reboot;
  -  ②Please check the power supply of DVR, if you installed a lot of hard disk drive, it may be reboot repeatedly underpower;
  -  ③Please pull up the network cable, then to check the DVR can work normally or not, being the catastrophe failure in network, it will cause the DVR reboot repeatedly;
- ?** 05: Why does the system halted of DVR during the playback and search the video file information in progress?
-  Please check if you install the hard disk drive or if the drive is ok or not? Please replace the good one for it soon;
  -  If the ambient temperature on the high side or not?
  -  Is there any heaven current installation surrounding and external video device, heavy current surging video cable, caused the DVR can not work properly and the system halted;
- ?** 06: Firmware upgrade failure?

🔧 U drive is not good compatible with the DVR, cause the DVR can not detected it, suggested to try one or two more different kind of U drive in the market;

🔧 USB interface is not good;

🔧 The voltage hunting fearfulness during the system firmware upgrade in progress;

? 07: Why the display color is black and white in TV and VGA monitor?

🔧 Check the video system is it matching the video input, DVR, TV or VGA monitor, if there is not on all fours, please set the video system mode in auto automatic recognition;

? 08: Why does nothing display on the TV or VGA monitor?

🔧 ①please make sure if the power supply of TV or VGA monitor turn on or not; if the illumination located in the lowest status?

🔧 ②if the video connected with TV or VGA monitor properly? Check if there is any video signal input? And make sure the line faulty or not?

? 09: Why does the video like water wave, to appear obstruction distortion?

🔧 ①if there is short circuit, open circuit or insufficient solder and connection failure of video cable?

🔧 ②If the video cable obstruction by high voltage interference, please separate the video and high voltage in linkup cabling, at the meantime, please select the better quality, shield video cable for the project;

🔧 ③In the whole system, only select the central point to grounding, please do not multi port to grounding, then, cause the common mode obstruction, please connect the screw in DVR rear panel to grounding;

🔧 ④Check if there is the become old problem in the camera or TV monitor and cable?

? 10: Why do the color of live video and record video data distortion?

🔧 ①Make sure the input and output video parameter of main menu setting correct;

🔧 ②Make sure the connection is correct;

? 11: Why does the video skew became deformed, color cast?

🔧 ①Make sure the VGA cable and DVR be connected with grounding properly;

🔧 ② The DVR working atmosphere temperature high, or no good in radiating, cause the VGA chipset working exceptional, or the mention circuit parameter is abnormal;

? 12: Why does the record video playback in mosaic under local DVR?

- 👉 ①The recording parameter setting is too low cause the record video quality overall down, sometime appears to mosaic;
- 👉 ②The record video file locates where there is a bad sector in a hard disk drive, it will cause the mosaic raising;